

Super Lumideck

Hanger Rod

ALL EXTRUDED HANGER ROD CANOPY



FEATURES

- Pre-engineered
- All Extruded
- Color Options
- High Load
- Deck Options - Flat Soffit
- Fascia/Escutcheon Options
- Internal Drainage



The Super Lumideck hanger rod canopy is an all extruded aluminum canopy designed for high load architectural applications. Optional deck styles provide a complete solution for any design requirement. Deck profiles can be combined with differing fascias to complement any design emphasis or building requirement. The all extruded design provides a solution for both high snow drift loads and hurricane force winds.

APPLICATIONS

- Retail Branding
- Storefronts
- Loading Docks
- Parking Garages
- Shopping Center
- Historical Renovation

For design and budget information, please visit
www.mapes.com/superlumideck_hanger

A. Wagner Oil C. Culver's
B. Prospect Park D. Nebraska Machine

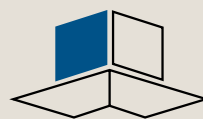

mapes
ARCHITECTURAL CANOPIES

Mapes Canopies, LLC
7748 North 56th Street / Lincoln, NE 68514
888-273-1132 / 877-455-6572 fax
canopy@mapes.com / www.mapescanopies.com

Super Lumideck

Backyard Burgers



HANGER ROD CONFIGURATIONS

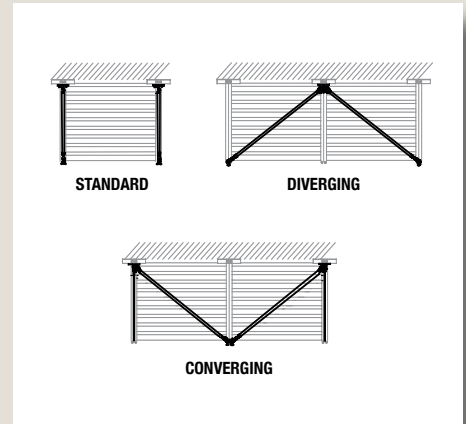

SECTION DETAIL

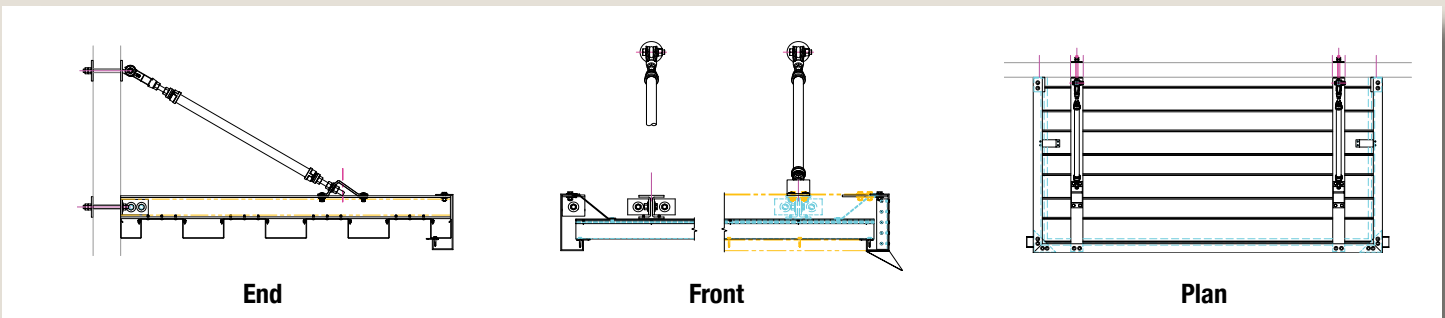

WALL MOUNT DETAILS

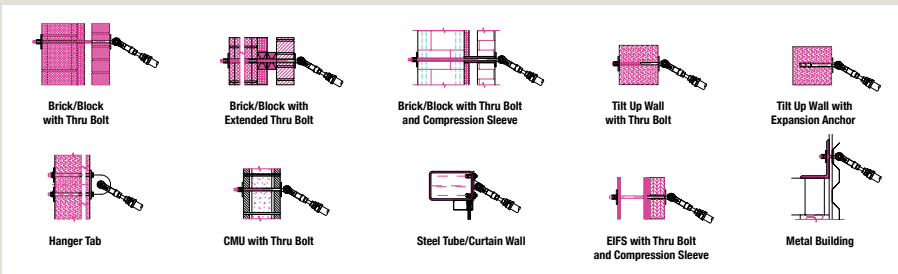

DECK OPTIONS

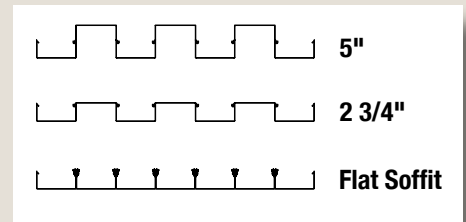

FASCIA OPTIONS

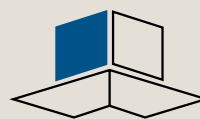
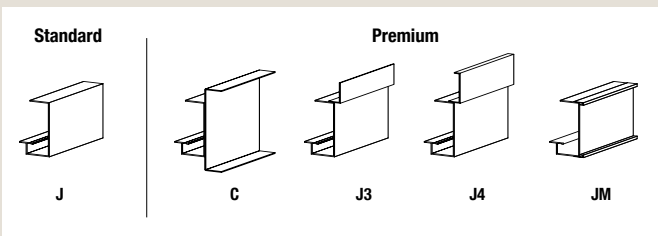

mapes
ARCHITECTURAL CANOPIES

Mapes Canopies, LLC
7748 North 56th Street / Lincoln, NE 68514
888-273-1132 / 877-455-6572 fax
canopy@mapes.com / www.mapescanopies.com

For more details, please visit mapes.com/superlumideck_hanger